

**WORKING TOGETHER
FOR A BETTER SOLUTION**

HC Hydro Custom

ELECTRIC MOTORS 
C FLANGES - DIRECT MOUNT
&
AC/DC - POWER UNITS

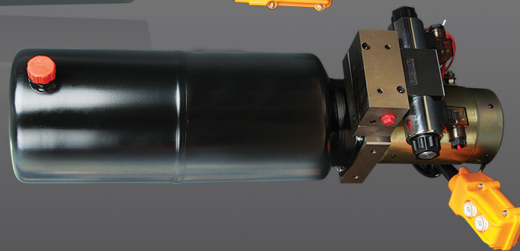

TEFC MOTORS

- CHOICE OF 1/3 TO 20HP
 - 1800 RPM (3600 RPM AVAILABLE)
 - SINGLE AND THREE PHASE
 - NEMA FRAME FROM 56 TO 215 TC
 - IP44 CLASS, 1.15 FS
- VOLTAGE AVAILABLE:
 - 115/220V
 - 575V
 - 208-230/460V



HP	PART NUMBERS			FRAME
	110/220V SINGLE PHASE	575V THREE PHASE	208-230/460V THREE PHASE	
1/3	F56C1/3S4C	F56C1/3M4D	F56C1/3M4A	56C
1/2	F56C1/2S4C	F56C1/2M4D	F56C1/2M4A	
3/4	F56C3/4S4C	F56C3/4M4D	F56C3/4M4A	
1	F56C1S4MOAG	F56C1M4D	F56C1M4A	
1.5	F56C1.5S4CMOAG	F56C1.5M4D	F56C1.5M4A	
2	F56C2S4CMOAG	F56C2M4D	F56C2M4A	
3	-	F182TC3M4D	F182TC3M4A	
5	-	F184TC5M4D	F184TC5M4A	184TC
7.5	-	F215TC7.5M4D	F215TC7.5M4A	213TC
10	-	F215TC10M4D	F215TC10M4A	215TC
15	-	F215TC15M4D	F215TC15M4A	254TC
20	-	F215TC20M4D	F215TC20M4A	256TC

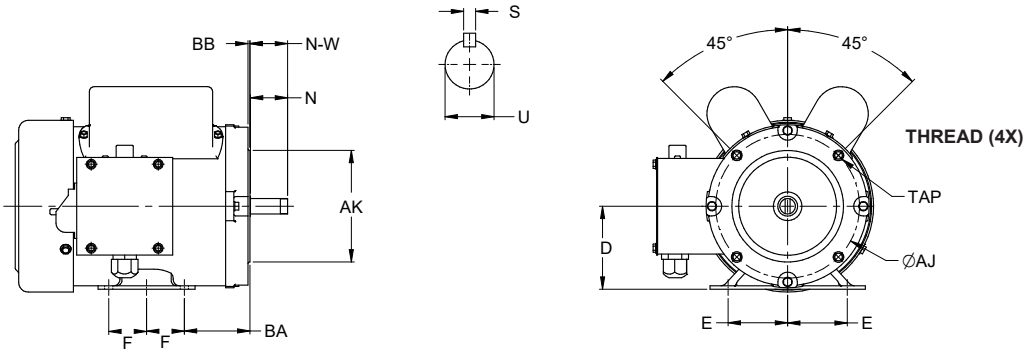
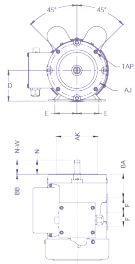

DIMENSIONS

FRAME SIZE	D	E	F	N	U	S	N-W	AJ	AK	BA	BB	THREAD
56C	3.500	2.438	1.5	1.937	0.625	0.188	1.880	5.875	4.500	2.750	0.160	3/8-16 UNC
143T 145T	3.5	2.75	2 2.5	2.31	0.875	0.188	2.25	5.875	4.5	2.25	0.16	3/8-16 UNC
182T 184T	4.500	3.750	2.250 2.750	2.875	1.125	0.250	2.750	7.250	8.500	2.750	0.250	1/2-12 UNC
213T	5.25	4.25	2.75	3.375	1.375	0.312	3.125	7.25	8.5	3.5	0.25	1/2-13 UNC
215T	5.250	4.250	3.500	3.375	1.375	0.312	3.125	7.250	8.500	3.500	0.250	1/2-13 UNC
254T 256T	6.25	5	4.125 5	4.32	1.625	0.375	4	7.25	8.5	4.75	0.25	1/2-13 UNC

Our power units follow the same vigorous production and assembly processes as the rest of our products. The Hydro Custom power units are used in various applications :

- Car Lift (ETL Certified)
- Snow Plow
- Dock Leveler
- Lift Table
- Scissor Lift
- Tail Gate
- Fork Lift
- Tipper Trailer
- Dump Trailer
- Garbage Truck
- RV
- Wheel Chair and Medical

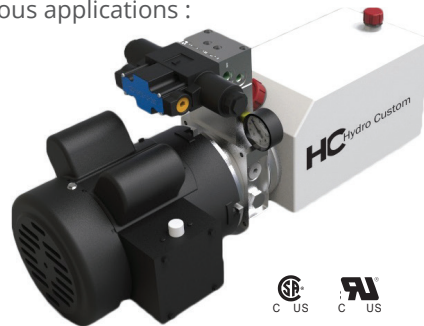

POWER UNITS

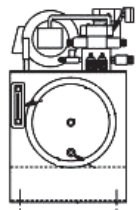
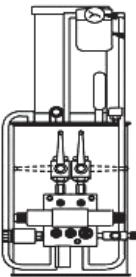

FEATURES AND BENEFITS

- Choice of configurations of multiple components such as pumps, valves, motors and tanks.
- Experienced advisers in hydraulic circuit conception that will help you with the design of powers units according to your needs and requirements.
- Power units can be fitted with blocks manifold designed to your specifications and manufactured in our workshops.
- Mounting and testing of power units in a clean environment and without contamination, according to procedures established by highly qualified technicians.
- Manufacturing customized solutions or series are possible taking into consideration the time of execution, the amount and the budgetary.
- Price constraints.
- 3D drawings, hydraulic and electrical plans and reports of tests (flow, pressure, speed, etc.) upon request.
- Variety of standard power units distributed in our three warehouses across North America.
- Several points of service in North America with hydraulic spare parts.
- Well studied Quality/Price Ratio in order to provide you with the best possible offer.

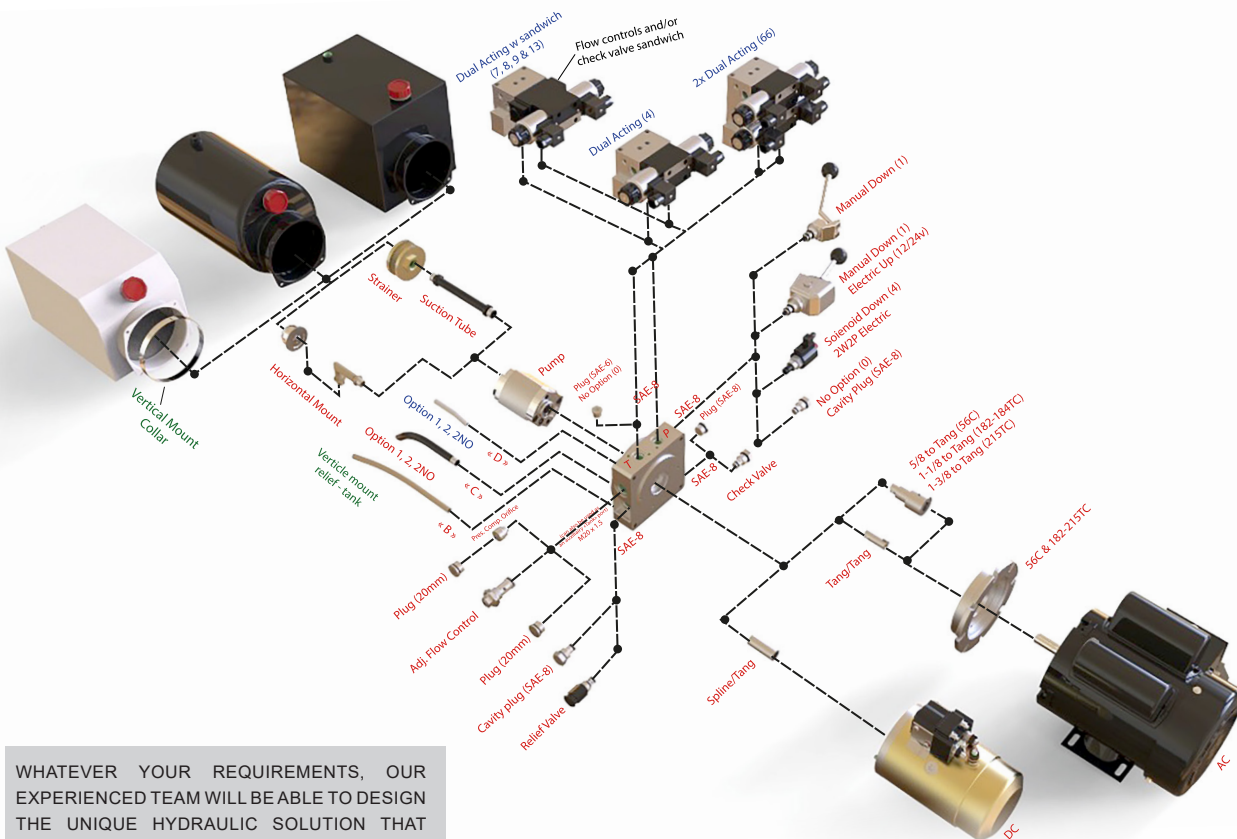

WHATEVER YOUR REQUIREMENTS, OUR EXPERIENCED TEAM WILL BE ABLE TO DESIGN THE UNIQUE HYDRAULIC SOLUTION THAT MEETS YOUR INDIVIDUAL SPECIFICATIONS. PROJECT APPRAISAL, INVENTORY REQUEST, AND ORDERS ARE ACCESSIBLE TO AFFILIATED DISTRIBUTORS.

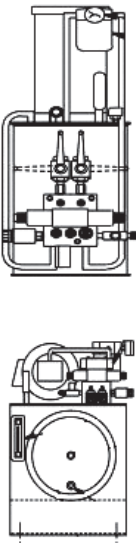

RESERVOIRS

BREATHER WITH DIPSTICK INCLUDED

PLASTIC HORIZONTAL

CODE	GALLONS	USABLE	DIMENSIONS
PR	1,0	0,7	7.1 SQ. X 7.9 LG.
PS	1,3	1,2	7.1 SQ. X 11.4 LG.
PT	1,6	1,6	7.1 SQ. X 13.2 LG.
PU	2,1	2,1	7.1 SQ. X 17.3 LG.
PV	2,6	2,6	7.1 SQ. X 20.9 LG.
PW	3,2	3,1	7.1 SQ. X 21.6 LG.

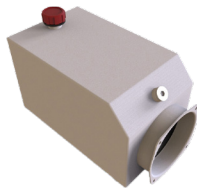

ROUND STEEL HORIZONTAL

CODE	GALLONS	USABLE	DIMENSIONS
RY	0,4	0,26	4.75 DIA. X 6.3 LG.
RZ	0,53	0,4	4.75 DIA. X 8.5 LG.
RA	1	0,8	7.0 DIA X 7.8 LG.
RB	1,3	1,3	7.0 DIA X 9.8 LG.
RC	2,1	2,1	7.0 DIA X 14.5 LG.
RD	2,6	2,6	7.0 DIA X 17.3 LG.



SQUARE STEEL HORIZONTAL

CODE	GALLONS	USABLE	DIMENSIONS
SD	2,6	2,2	7.7W X 8.25H X 10.2 LG.
SE	3,2	2,6	7.7W X 8.25H X 11.8 LG.
SF	4	3,5	7.7W X 8.25H X 16.1 LG.
SH	5,3	4,7	7.7W X 8.25H X 21 LG.
SJ	6,6	6,2	7.7W X 8.25H X 27.8 LG.



PLACTIC VERTICAL

CODE	GALLONS	USABLE	DIMENSIONS
QR	1,0	0,79	7.1 SQ. X 7.9 LG.
QS	1,3	1,3	7.1 SQ. X 11.4 LG.
QT	1,6	1,5	7.1 SQ. X 13.2 LG.
QU	2,1	2,1	7.1 SQ. X 17.3 LG.
QV	2,6	2,6	7.1 SQ. X 20.9 LG.
QW	3,2	2,7	7.1 SQ. X 21.6 LG.



ROUND STEEL VERTICAL

CODE	GALLONS	USABLE	DIMENSIONS
TK	0,8	0,5	7.0 DIA X 7.8 LG.
TL	1,3	1,2	7.0 DIA X 11.8 LG.
TM	2,6	2,1	7.0 DIA X 17.3 LG.
TN	3,2	2,7	7.0 DIA X 21.2 LG.



SQUARE STEEL VERTICAL

CODE	GALLONS	USABLE	DIMENSIONS
UE	3,2	2,9	7.7W X 8.25H X 11.8 LG.
UP	4,2	3,9	7.1 SQ. X 23.2 LG.
UQ	5,5	5,1	7.1 SQ. X 29.1 LG.
U2	6,6	6,6	11 X 13.5 X 11.8 LG.
U4	10,6	10,6	11 X 13.5 X 18 LG.



SCHEMATIC

RELIEF VALVE INCLUDED UNLESS SPECIFIED

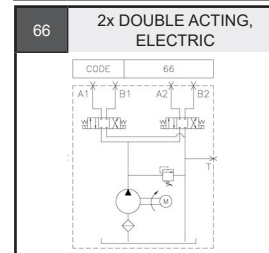
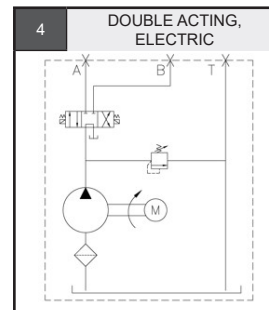
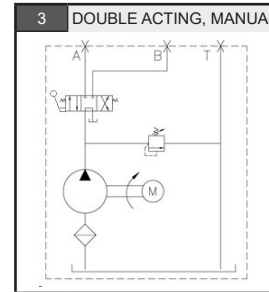
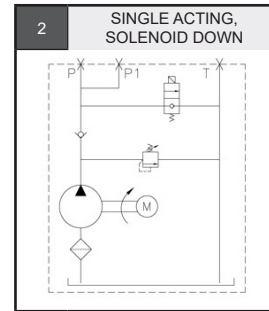
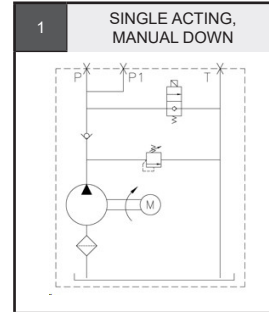
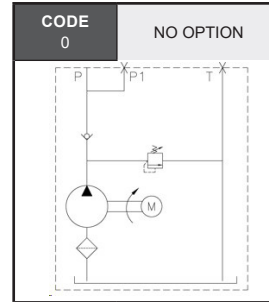

SNOW PLOW UNITS

UNIT PART NUMBER: 1W2W-F2.5ZR14A
REMOTE PART NUMBER: SP4AF1

- 12V DC POWER UNIT FOR SNOW PLOW APPLICATION
- CUSHION VALVE TO ABSORB SHOCKS ON LEFT-RIGHT MOVEMENT
- MADE FOR 3 SINGLE ACTING CYLINDERS
- 1/2 GALLONS TANK
- SAE-06 PORTS
- 2 AXIS JOYSTICK (LEFT, RIGHT, UP & DOWN)
- ROCKER SWITCH WITH LIGHT TO ACTIVATE FLOAT POSITION
- 10 FOOT CABLE
- DIMENSIONS OF 15" X 10" X 6 3/4"

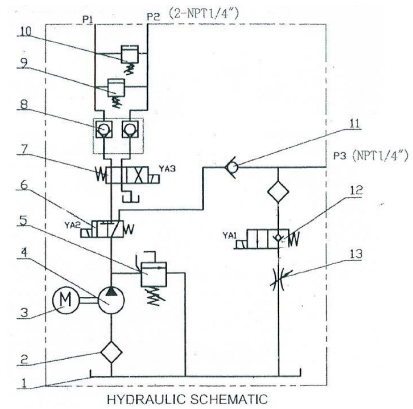
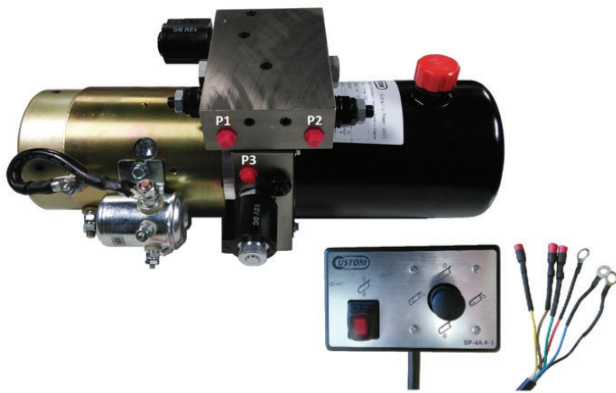

DIRECT MOUNT "PUMP-MOTOR ASSEMBLIES"

FEATURES AND BENEFITS

- VERY ECONOMICAL & COMPACT DESIGN
- DIRECTLY ON ELECTRIC MOTORS.
- DIRECT MOUNT" MOTOR CAN BE ORDERED SEPARATELY

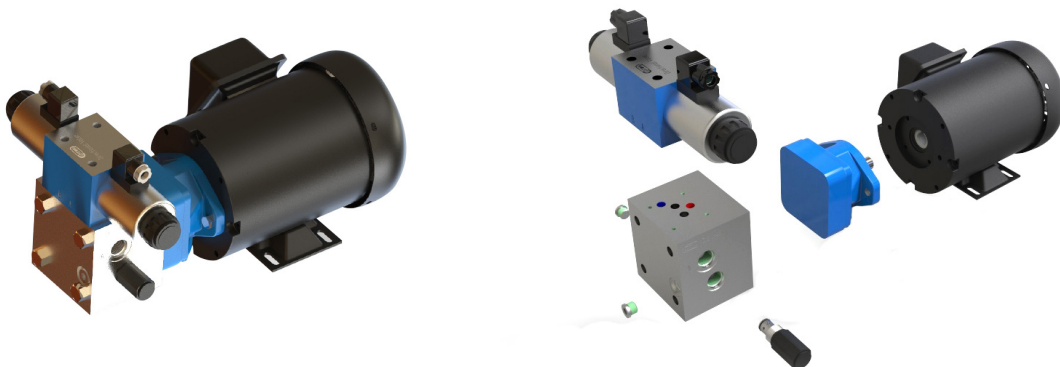

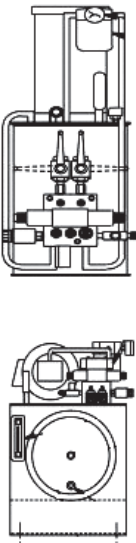

MODEL CODE

EXAMPLE
DM56CS4C - 4PS2.8

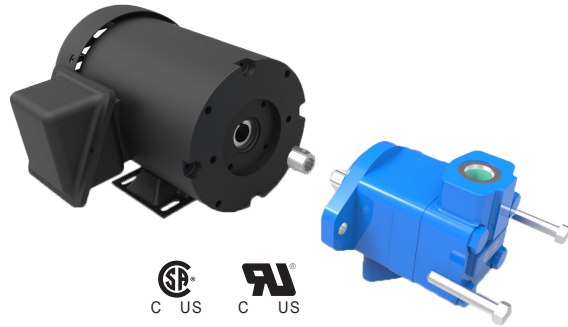
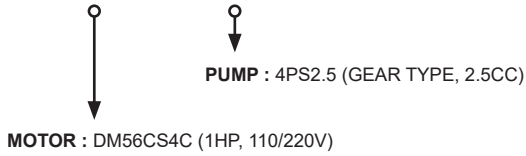

MOTORS - TEFC - 1800 RPM

HP	PART NUMBERS			FRAME	PUMP SIDE FLANGE & SHAFT
	110/220V SINGLE PHASE	575V THREE PHASE	208-230/460V THREE PHASE		
0,50	DM56C1/2S4CF	-	-	56C	SAE A-2B FLANGE AND SAE AA-4B FLANGE
0,75	DM56C3/4S4CF	-	-		
1	DM56C1S4CF	-	-		
1,5	DM56C1.5S4CF	-	-		
2	DM56C2S4CF	-	-		
3	DM56C3S4CF	-	-		
5	-	DM215TC3M4DF	DM215TC3P4AF	215TC	SAE A-2B FLANGE
7,5	-	DM215TC5M4DF	DM215TC5P4AF		
10	-	DM215TC7.5M4DF	DM215TC7.5P4AF		
15	-	DM215TC10M4DF	DM215TC10P4AF		
20	-	DM215TC15M4DF	DM215TC15P4AF		
20	-	DM215TC20M4DF	DM215TC20P4AF		

PUMPS

GEAR TYPE

CODE	GPM	MODEL
4PS1.4	0,71	1.5 PE PAGE 62
4PS2.1	1,00	
4PS2.8	1,23	
4PS3.5	1,71	
2PS4.5	2,1	2 PE PAGE 63
2PS6.5	3,12	
2PS8.3	3,9	
2PS11.3	5,3	
2PS13.8	6,55	
2PS16	7,87	

VANE TYPE

CODE	GPM	MODEL
22S1	1,5	V10 PAGE 69
22S2	3,0	
22S3	4,5	
22S4	6,0	
22S5	7,5	
22S6	9,0	
22S7	10,5	V20 PAGE 69
22S8	12,0	
22S9	13,5	
22S10	15,0	
22S11	16,5	
22S12	18,0	
22S13	19,5	

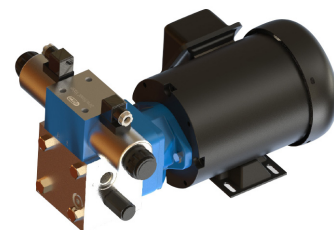
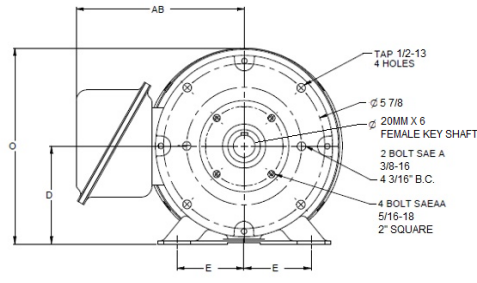
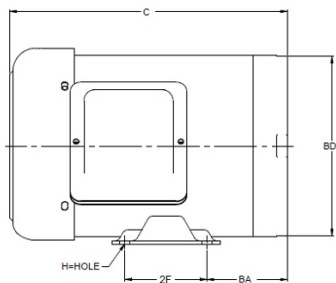

ALSO AVAILABLE

- HYDRAULIC CIRCUIT DIRECTLY MOUNTED ON THE PUMP
- VERY COMPACT DESIGN. LESS PIPING
- MANY OPTIONS

FRAME	C	D	E	2F	H	O	BD	AB	BA
56C	10 1/8	3 1/2	2 7/16	3	11/32 SLOTS	7	6 1/2 DIA	6 1/8	2 15/16
215TC	15 5/8	5 1/4	4 1/4	7	13/32 DIA	11	8 1/2 DIA	8 3/8	3 1/2

OUR MISSION IS FOR YOU **TO ACHIEVE YOUR GOALS** BY PROVIDING INNOVATIVE & QUALITY PRODUCTS.

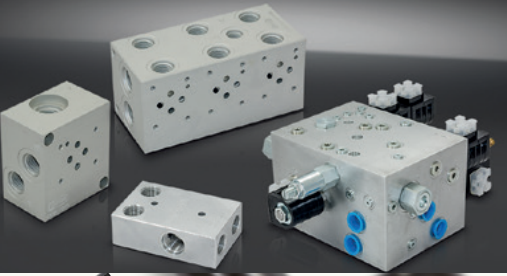

HC

Hydro Custom

hhydrocustom.com

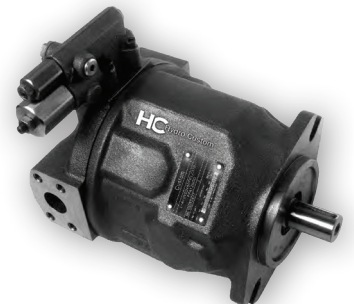
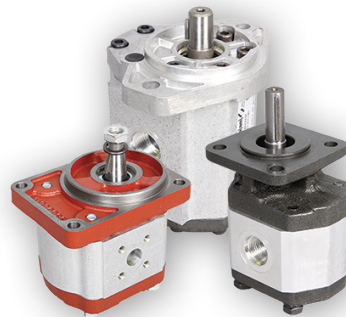

FOR ALL YOUR HYDRAULIC NEEDS

